

Data Sheet

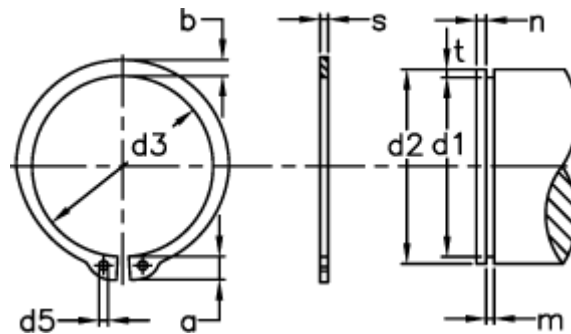

Article number: 0109052
 Description: Retaining ring AS 35x2.5
 Spring steel
 Note: Fitted with ZGA pliers

Measures



a max	= 6.7	Description	= AS 35	s	= 2.50
AN mm ²	= 107.0	FN kN	= 17.80	t	= 1.00
B	= 2.78	FRg kN	= 15.4	tol	= -0.25
b	= 4.2	FR kN	= 86.0	tol	= -0.07
d1	= 33.0	g	= 1.5	tol	= +0,25 -0,50
d2	= 35	m min	= 2.65	Tong	= ZGA-3
d3	= 32.2	n abl x 1000	= 17	Weight kg/1000	= 7.10
d5 min	= 2.5	Nominal drive	= 3.0		